

# +GF+ SIGNET 515/2536 Rotor-X Flow Sensors



## Features

- PVDF or Polypropylene molded sensor body
- Simple insertion design
- Separate versions for remote and integral installations
- Wide Turndown Ratio of 66:1 for 2536, 20:1 for 515
- Use with comprehensive line of fittings from DN15 to DN1000 (0.5 to 36 in.)
- Process Ready Signal (3-2536-XX)
- Extended length for wet-tap installations available

## Application

- Pure Water Production
- Filtration Systems
- Chemical Production
- Liquid Delivery Systems
- Pump Protection
- Scrubbers

## Options

Rotor-X Sensors	Instrument Options									
	8550-1	8550-2	8550-3	8550-XP	5090	5075	5100	5500	5600	9010
515	●	●	●	●	●	●	●	●	●	●
8510	●	●	●							
2536	●	●	●	●	●	●	●	●	●	●
8512	●	●	●							

## Description

Simple and reliable, Rotor-X paddlewheel flow sensors deliver time-honored performance. These highly repeatable, rugged sensors offer exceptional value with little or no maintenance required. Installation is simple with +GF+ SIGNET's comprehensive line of fittings for all pipe materi-

als in sizes from DN15 to DN1000 (0.5 to 36 in.). Output signal of the 515 is a sinusoidal frequency capable of driving a self-powered flowmeter (3-5090). The 3-2536 has a process-ready open-collector signal and can operate to flows as low as 0.1 m/s (0.3 ft/s).

## Technical Features

- Integral mount sensor (8510/8512) shown with field-mount transmitter (sold separately)
- Remote mount sensor (515/2536)
- Open cell rotor and rotor pins available in variety of material options (sleeved rotor available for abrasive solutions)
- 1/2 in. NPT conduit connection
- 7.6m/25 ft. cable standard, extendable up to 60m/200 ft. (515) or 305m/1,000 ft. (2536)
- Large bail for sensor removal
- Glass-filled PP ring nut with provision for lead seal installation
- Dual O-ring seal (FPM standard, EPR and Kalrez® available)
- One-piece injection molded (black glass-filled PP or natural PVDF) sensor body
- Rotor pin

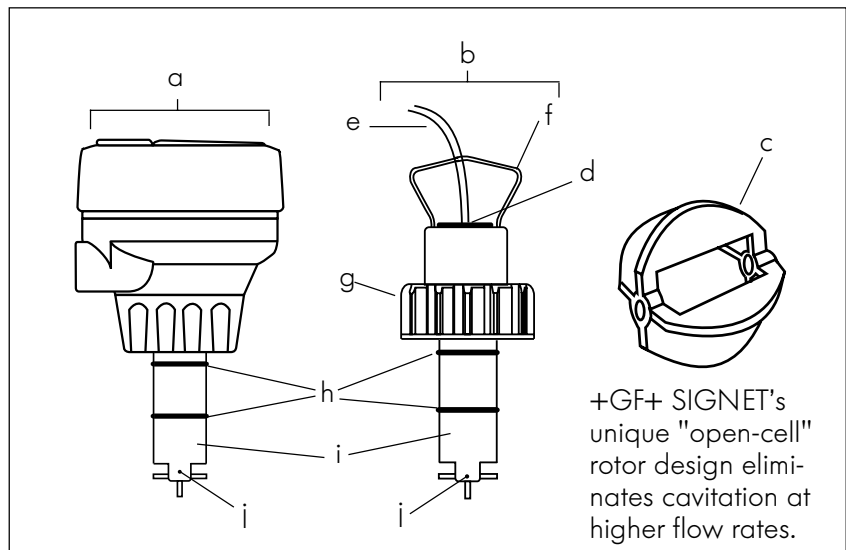

+GF+ SIGNET's unique "open-cell" rotor design eliminates cavitation at higher flow rates.

# Dimensions

## 515/2536 Sensor

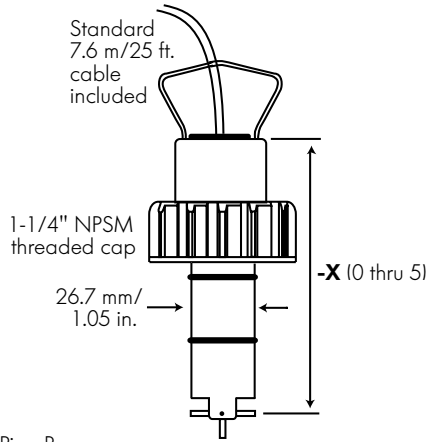

Pipe Range:

- 1/2 to 4 in. -X0 = 104 mm/4.1 in.
  - 5 to 8 in. -X1 = 137 mm/5.4 in.
  - 10" and up -X2 = 213 mm/8.4 in.
  - 1/2 to 4 in. -X3 = 297 mm/11.7 in.
  - 5 to 8 in. -X4 = 333 mm/13.1 in.
  - 10" and up -X5 = 409 mm/16.1 in.
- } Wet-tap Lengths

## 8512 Integral Sensor with Transmitter (sold separately)

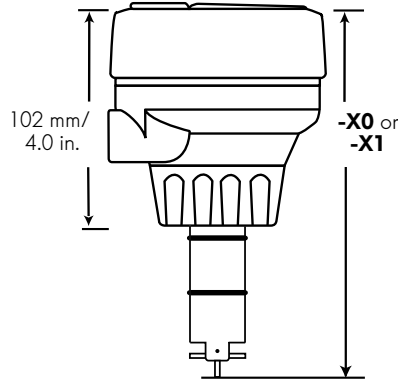





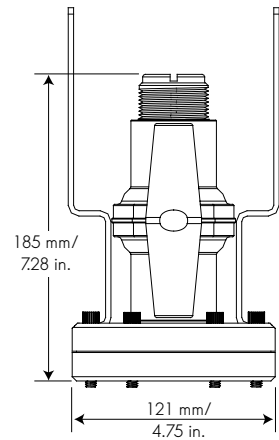
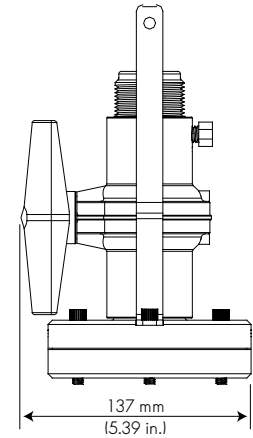



- X0 = 152 mm/6.0 in.
- X1 = 185 mm/7.3 in.

## 3519 Wet Tap Assembly (see catalog page for details)

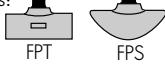

# Fitting Types

Refer to Fittings section of +GF+ SIGNET catalog for a complete listing of part numbers

Type	Description	Type	Description
 <p>Plastic tees</p>	<ul style="list-style-type: none"> <li>• 0.5 to 4 inch versions</li> <li>• PVC or CPVC</li> </ul>	 <p>Iron, Carbon Steel, 316 SS Threaded tees</p>	<ul style="list-style-type: none"> <li>• 0.5 to 2 in. versions</li> <li>• Mounts on threaded pipe ends</li> </ul>
 <p>PVC Glue-on Saddles</p>	<ul style="list-style-type: none"> <li>• Available in 10 and 12 inch sizes only</li> <li>• Cut 2-1/2 inch hole in pipe</li> <li>• Weld in place using solvent cement</li> </ul>	 <p>Carbon steel &amp; stainless steel Weld-on Weldolets</p>	<ul style="list-style-type: none"> <li>• 2 to 4 inch, cut 1-7/16 inch hole in pipe</li> <li>• Over 4 inch, cut 2-1/4 inch hole in pipe</li> </ul>
 <p>PVC Saddles</p>	<ul style="list-style-type: none"> <li>• 2 to 4 inch, cut 1-7/16 inch hole in pipe</li> <li>• 6 to 8 inch, cut 2-1/4 inch hole in pipe</li> </ul>	 <p>Fiberglass tees &amp; saddles:</p>	<ul style="list-style-type: none"> <li>• 1.5 in. to 8 in. PVDF insert</li> <li>• &gt; 8 in. PVC insert</li> <li>• Special order 12 in. to 36 in.</li> </ul>
 <p>PP Clamp-on Saddles</p>	<ul style="list-style-type: none"> <li>• Available in 10 and 12 inch sizes only</li> <li>• Cut 2-1/4 inch hole in pipe</li> </ul>	 <p>Metric Wafer Fitting</p>	<ul style="list-style-type: none"> <li>• For pipes DN 65 to 200 mm</li> <li>• PP or PVDF</li> </ul>
 <p>Iron Strap-on saddles</p>	<ul style="list-style-type: none"> <li>• 2 to 4 inch, cut 1-7/16 inch hole in pipe</li> <li>• Over 4 inch, cut 2-1/4 inch hole in pipe</li> <li>• Special order 12 in. to 36 in.</li> </ul>	 <p>Metric Union Fitting</p>	<ul style="list-style-type: none"> <li>• For pipes from DN 15 to 50 mm</li> <li>• PP or PVDF</li> </ul>

## Installation

- Six common installation configurations are shown here as guidelines to help you select the best location in your piping system for a paddlewheel flow sensor.
- Always maximize distance between sensors and pump sources.

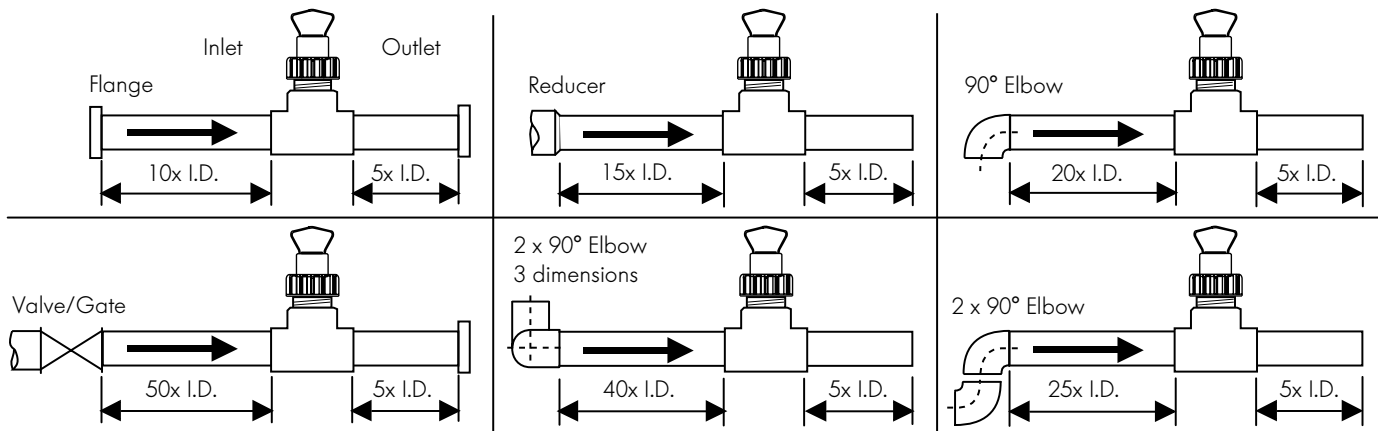

## Sensor Mounting Position

- Horizontal pipe runs: Mount sensor in a vertical position for best performance, or at a maximum 45° angle to avoid air bubbles (pipe must be full). Do not mount the sensor on the bottom of the pipe if sedimentation is likely.
- Vertical pipe runs: Mount sensor in any orientation. Upward flow is preferred to ensure full pipe.

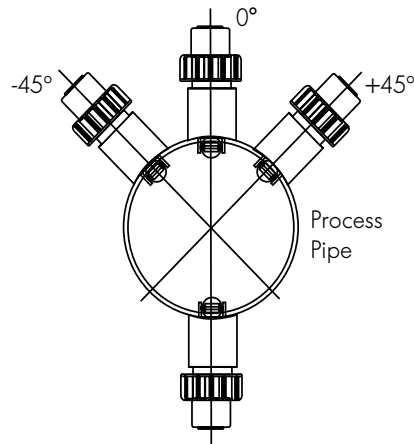

## Maximum Operating Pressure/Temperature

### 515 Sensor:

Glass-filled Polypropylene Body:

12.5 bar (180 psi) max. @ 20°C (68°F)

1.7 bar (25 psi) max. @ 90°C (194°F)

PVDF Body:

14 bar (200 psi) max. @ 20°C (68°F)

1.7 bar (25 psi) max. @ 100°C (212°F)

### 2536 Sensor:

Polypropylene Body:

12.5 bar (180 psi) max. @ 20°C (68°F)

1.7 bar (25 psi) max. @ 85°C (185°F)

PVDF Body:

14 bar (200 psi) max. @ 20°C (68°F)

1.7 bar (25 psi) max. @ 85°C (185°F)

### 3519 Wet-Tap:

7 bar (100psi) max. @ -18° to 20°C (0° to 68°F)

1.4 bar (20 psi) max. @ 66°C (150°F)

Note: Wet-tap max. installation/removal pressure:

1.7 bar (25 psi) @ 22°C (72°F).

### 515 Sensor

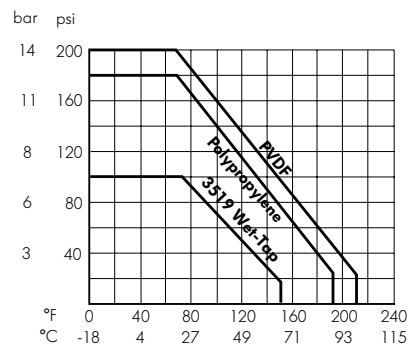

### 2536 Sensor

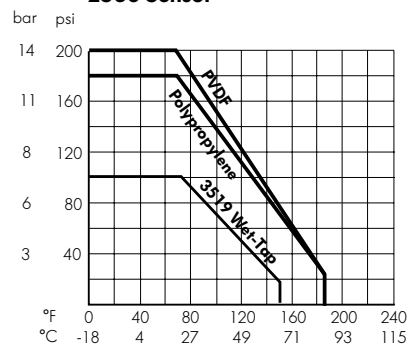

## Wiring

### 515 Sensor Connection to +GF+ SIGNET Instruments

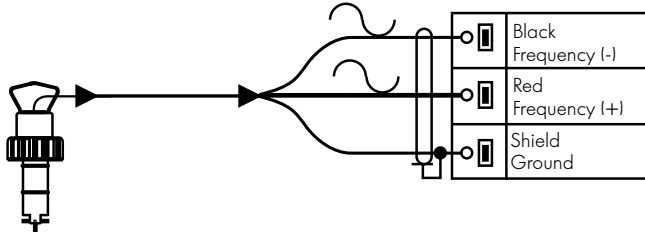

### 2536 Sensor Connection to +GF+ SIGNET Instruments

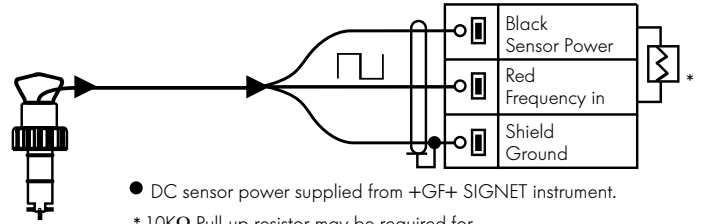

● DC sensor power supplied from +GF+ SIGNET instrument.

\* 10K $\Omega$  Pull-up resistor may be required for non +GF+ SIGNET brand instrument

## Technical Data

### General (for both 515 & 2536)

Pipe Size Range: 15 to 1000 mm (0.5 to 36 in.)

Linearity:  $\pm 1\%$  of full range

Repeatability:  $\pm 0.5\%$  of full range

Minimum Reynolds Number Required: 4500

Wetted Materials:

Sensor Body: Glass-filled Polypropylene (black) or PVDF (natural)

O-rings: FPM-Viton<sup>®</sup> (std) or EPDM or FPM-Kalrez<sup>®</sup>

Pin: Titanium or Hastelloy-C or PVDF; other material options available

Rotor: Black PVDF or Natural PVDF; optional Tefzel with or w/o Fluoraloy B<sup>®</sup> sleeve

Cable Type: 2-conductor twisted pair with shield (22 AWG)

Shipping Weight:	-X0	0.454 kg	1 lb.
	-X1	0.476 kg	1.04 lbs.
	-X2	0.680 kg	1.50 lbs.
	-X3	0.794 kg	1.75 lbs.
	-X4	0.850 kg	1.87 lbs.
	-X5	1 kg	2.20 lbs.
	3519	1.3 kg	2.86 lbs.

### Standards and Approvals (for both 515 & 2536):

- Manufactured under ISO 9001 and ISO 14001
- CE

### General (515 Only)

Flow Rate Range: 0.3 to 6 m/s (1 to 20 ft./s)

Pipe Size Range: DN15 to DN1000 (0.5 to 36 in.)

Cable Length: 7.6 m (25 ft.) standard/60 m (200 ft.) maximum

Signal:

Frequency: 19.7 Hz per m/s nominal (6 Hz per ft/s)

Amplitude: 3.3 V p/p per m/s nominal (1 V p/p per ft/s)

Source Impedance: 8  $\Omega$

### Standards and Approvals (515 only):

- FM Class I, II, III/Div./groups A-G

### General (2536 Only)

Flow Rate Range: 0.1 to 6 m/s (0.3 to 20 ft./s)

Pipe Size Range: DN15 to DN1000 (0.5 to 36 in.)

Cable Length: 7.6 m (25 ft.) standard/305 m (1,000 ft.) maximum

Signal:

Frequency: 49Hz per m/s nominal (15 Hz per ft/s nominal)

Supply voltage: 3.5 to 24 VDC regulated

Supply current: <1.5 mA @ 3.3 to 6 VDC

<20 mA @ 6 to 24 VDC

Output Type: Open collector transistor, sinking

Output Current: 10 mA max.

## Ordering Information

### 515/8510-XX (Sinusoidal)

Mfr. Part No.	Code	Pipe Sizes	Body	Rotor/Pin
<b>Remote</b>				
P51530-H0	198 801 659	0.5 to 4 in.	Polypro	Blk PVDF/Hastelloy-C
P51530-P0	198 801 620	0.5 to 4 in.	Polypro	Blk PVDF/Titanium
P51530-P1	198 801 621	5 to 8 in.	Polypro	Blk PVDF/Titanium
P51530-P2	198 801 622	10 to 36 in.	Polypro	Blk PVDF/Titanium
<b>Remote Wet-Tap</b>				
P51530-P3	198 840 310	0.5 to 4 in.	Polypro	Blk PVDF/Titanium
P51530-P4	198 840 311	5 to 8 in.	Polypro	Blk PVDF/Titanium
P51530-P5	198 840 312	10 to 36 in.	Polypro	Blk PVDF/Titanium
<b>Remote</b>				
P51530-S0	198 801 661	0.5 to 4 in.	Polypro	Blk PVDF/Natural PVDF
P51530-T0	198 801 663	0.5 to 4 in.	Natural PVDF	Natural PVDF
P51530-T1	198 801 664	5 to 8 in.	Natural PVDF	Natural PVDF
P51530-V0	198 801 623	0.5 to 4 in.	Natural PVDF	Nat. PVDF/Hastelloy-C
P51530-V1	198 801 624	5 to 8 in.	Natural PVDF	Nat. PVDF/Hastelloy-C
P51530-V2	198 801 625	10 to 36 in.	Natural PVDF	Nat. PVDF/Hastelloy-C
<b>Integral</b>				
3-8510-P0	198 864 504	0.5 to 4 in.	Polypro	Blk PVDF/Titanium
3-8510-P1	198 864 505	5 to 8 in.	Polypro	Blk PVDF/Titanium
3-8510-T0	159 000 622	0.5 to 4 in.	Natural PVDF	Natural PVDF
3-8510-V0	198 864 506	0.5 to 4 in.	Natural PVDF	Nat. PVDF/Hastelloy-C

### 2536/8512-XX (Open-Collector)

<b>Remote</b>				
3-2536-P0	198 840 143	0.5 to 4 in.	Polypro	Blk PVDF/Titanium
3-2536-P1	198 840 144	5 to 8 in.	Polypro	Blk PVDF/Titanium
3-2536-P2	198 840 145	10 to 36 in.	Polypro	Blk PVDF/Titanium
3-2536-T0	198 840 149	0.5 to 4 in.	Polypro	Natural PVDF
3-2536-V0	198 840 146	0.5 to 4 in.	Natural PVDF	Nat. PVDF/Hastelloy-C
3-2536-V1	198 840 147	5 to 8 in.	Natural PVDF	Nat. PVDF/Hastelloy-C
<b>Remote Wet-Tap</b>				
3-2536-P3	159 000 758	0.5 to 4 in.	Polypro	Blk PVDF/Titanium
3-2536-P4	159 000 759	5 to 8 in.	Polypro	Blk PVDF/Titanium
3-2536-P5	159 000 760	10 to 36 in.	Polypro	Blk PVDF/Titanium
<b>Integral</b>				
3-8512-P0	198 864 513	0.5 to 4 in.	Polypro	Blk PVDF/Titanium
3-8512-P1	198 864 514	5 to 8 in.	Polypro	Blk PVDF/Titanium
3-8512-T0	198 864 518	0.5 to 4 in.	Natural PVDF	Natural PVDF
3-8512-V0	198 864 516	0.5 to 4 in.	Natural PVDF	Nat. PVDF/Hastelloy-C

### Wet-Tap Sensor and Valve Assembly (Fitting Separate)

<b>Remote Wet-Tap</b>				
3519/515-P3	159 000 819	0.5 to 4 in.	Polypro	Blk PVDF/Titanium
3519/515-P4	159 000 820	5 to 8 in.	Polypro	Blk PVDF/Titanium
3519/515-P5	159 000 821	10 to 36 in.	Polypro	Blk PVDF/Titanium
3519/2536-P3	159 000 822	0.5 to 4 in.	Polypro	Blk PVDF/Titanium
3519/2536-P4	159 000 823	5 to 8 in.	Polypro	Blk PVDF/Titanium
3519/2536-P5	159 000 824	10 to 36 in.	Polypro	Blk PVDF/Titanium

## Accessories

Mfr. Part No.	Code	Description
<b>Rotors 515/8510-XX</b>		
M1538-2	198 801 181	Rotor, PVDF Black
P51547-3	159 000 474	Rotor, PVDF Natural
M1538-4	198 820 018	Rotor, Tefzel®
P51550-3	198 820 043	Rotor and Pin, PVDF Natural
3-0515.322-1	198 820 059	Sleeved Rotor, PVDF Black
3-0515.322-2	198 820 060	Sleeved Rotor, PVDF Natural
3-0515.322-3	198 820 017	Sleeved Rotor, Tefzel®

## Accessories (continued)

Mfr. Part No.	Code	Description
<b>Rotors 2536/8512-XX</b>		
3-2536.320-1	198 820 052	Rotor, PVDF Black
3-2536.320-2	159 000 272	Rotor, PVDF Natural
3-2536.320-3	159 000 273	Rotor, Tefzel®
3-2536.321	198 820 054	Rotor and Pin, PVDF Natural
3-2536.322-1	198 820 056	Sleeved Rotor, PVDF Black
3-2536.322-2	198 820 057	Sleeved Rotor, PVDF Natural
3-2536.322-3	198 820 058	Sleeved Rotor, Tefzel®
<b>Rotor Pins</b>		
M1546-1	198 801 182	Pin, Titanium
M1546-2	198 801 183	Pin, Hastelloy-C
M1546-3	198 820 014	Pin, Tantalum
M1546-4	198 820 015	Pin, Stainless Steel
P51545	198 820 016	Pin, Ceramic
<b>O-Rings</b>		
1220-0021	198 801 186	O-Ring, FPM-Viton®
1224-0021	198 820 006	O-Ring, EPDM
1228-0021	198 820 007	O-Ring, FPM-Kalrez®
<b>Miscellaneous</b>		
P31536	198 840 201	Sensor Plug, Polypro
P31536-1	198 840 202	Sensor Plug, PVDF Metric
P31536-2	159 000 649	Sensor Plug, PVDF
P31542	198 801 630	Sensor Cap, Red (for use w/515)
P31542-3	159 000 464	Sensor Cap, Blue (for use w/2536)
P31934	159 000 466	Conduit Cap
P51589	159 000 476	Conduit Adapter Kit
5523-0222	159 000 392	Cable (per foot), 2 cond. w/shield, 22 AWG
3-8051	159 000 187	Transmitter Integral Adapter

## Engineering Specifications for both 515 and 2536 Flow Sensors

- The flow sensor shall use a four-blade, open-cell rotor design using insertion paddlewheel technology.
- Linearity of the output signal with respect to flow rate shall be  $\pm 1\%$  of full range.
- Measurement repeatability of the output signal with respect to flow rate shall be  $\pm 0.5\%$  of full range.
- The sensor body shall be made of injection-molded polypropylene (PP) that shall accommodate up to 12.5 bar @ 20°C (180 psi @ 68°F) and 1.7 bar @ 90°C (25 psi @ 194°F). As an alternative, the sensor shall be made of injection-molded polyvinylidene fluoride (PVDF) that shall accommodate up to 14 bar @ 20°C (200 psi @ 68°F) and 1.7 bar @ 100°C (25 psi @ 212°F).
- The sensor shall attach to a pipe via a variety of insertion-style installation fittings supplied by the flow sensor manufacturer. Attachment shall use a 1-1/4 X 11-1/2 NPSM threaded cap. Sealing shall be accomplished with a double O-ring seal. O-rings shall be made of FPM-Viton®, FPM-Kalrez® or EPDM.
- The sensor shall be equipped with 0.5 in. female conduit connection.

## Engineering Specifications for +GF+ SIGNET 515 Rotor-X Flow Sensor

- The sensor shall require no electrical power.
- The sensor shall provide an output signal of 3.3 V p-p per m/s nominal (1 V p-p per ft/s) at a frequency of 19.7 Hz per m/s nominal (6 Hz per ft/s) from 0.3 to 6 m/s (1 to 20 ft/s).
- Output shall be via a twisted pair, foil-shielded cable with drain wire. Supplied cable shall be at least 7.6 m (25 ft) long, with a maximum allowable length of 60 m (200 ft).
- The operating range of the sensor shall accommodate nominal flow rates from 0.3 to 6 m/s (1 to 20 ft/s).
- The sensor shall meet appropriate CE standards and FM standards for Classes 1, 11 and 111, Division I/Groups A-G.

## Engineering Specifications for +GF+ SIGNET 2536 Low Flow Sensor

- The sensor shall operate with a power input of 3.3 to 6VDC @ <1.5 mA or from 6 to 24 VDC @ <20 mA.
- The sensor output shall provide an open-collector pulse at a frequency of 49.2 Hz per m/s nominal (15 Hz per ft/s).
- Output shall be via a twisted pair, foil-shielded cable with drain wire. Supplied cable shall be at least 7.6 m (25 ft) long, with a maximum allowable length of 305 m (1000 ft).
- The operating range of the sensor shall accommodate nominal flow rates from 0.1 to 6 m/s (0.3 to 20 ft/s).
- The sensor shall meet appropriate CE standards.

Viton®, Tefzel® and Kalrez® are registered trademarks of DuPont Dow Elastomers.