

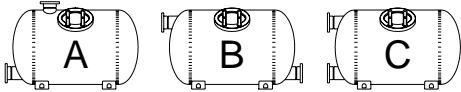

Styles:



STARK® SL Series™ Horizontal Sand Filtration Systems



***For use in commercial pool, water park,
and many aquarium applications.
Standard systems accommodate flows
from 135 to 2,500 GPM – custom
systems accommodate unlimited flows.***

All Stark SL Series vessels are corrosion-proof, composite vessels. Systems are available with either 75 psi rated filament-wound vessels (S Series) or 50 psi rated unwound vessels (L Series) to meet multiple budgets and specifications. All vessels are 42" Diameter to offer the best combination of cost and effectiveness for recreational water. Stark Diaphragm Valves and Controls are Standard; butterfly-valve options (including linked valves) are also available.

Feature Summary

- All vessel models are NSF listed.
 - Solid composite construction – does not employ a bladder.
- Vessels can be stacked to minimize footprint. Designed for Seismic Zone 4 loading without additional supports or braces.
- Vessels feature proprietary PARACOTE® All-Weather Exterior Coating with UV Inhibitors.
 - Several backwash control options available.

STARK® SL Series™

Horizontal Sand Filtration Systems



Semi-Automatic Single-Knob Backwash Control with Pressure Gages is Standard

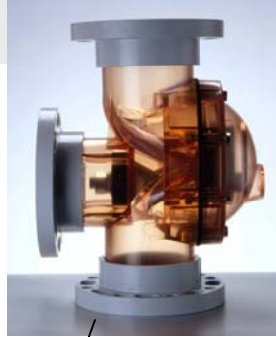

6" Backwash Valves (on most models) include a **transparent ABS valve housing and cover** to readily display valve positioning and provide convenient maintenance inspections.



Optional Auto Backwash



Manual Air Relief is Standard

Vessel can be manufactured with 12" X 16" access Manway on either side of the vessel – 'Standard' or 'Reversed'.

Multiple influent and effluent pipe locations available – A, B, & C-Style.

Additional System Features & Options

- Diaphragm-type Priority Valve on 2-Tank Systems.
- Optional 24 VAC Re-Programmable Fully-Automatic Backwash Controller; flow meter and temperature probe for real-time display can be added.



Optional Backwash Controller Interface provides convenient interface with multi-purpose controllers (e.g. Chemtrol®, Acu-Trol™) and PLC's.

- Optional Para-Pump Pressure Booster System provides consistent valve-actuation where city-water pressure is unreliable.

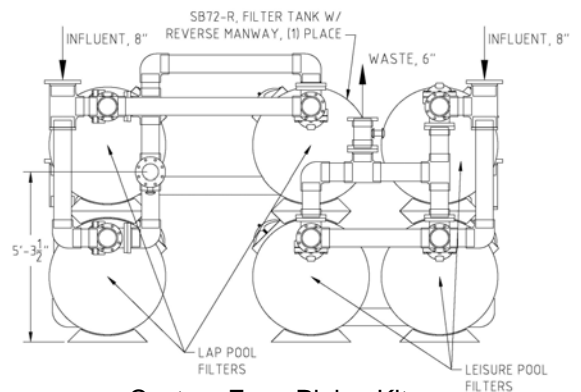

Custom Face-Piping Kits for your Application.

Styles:

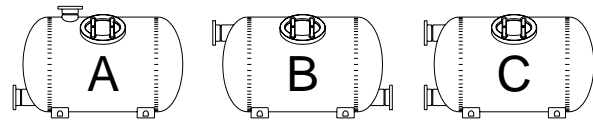

Systems are available with either 75 psi rated filament-wound vessels (S Series) or 50 psi rated unwound vessels (L Series) to meet multiple budgets and specifications.

Vessel Comparison	S Series	L Series
Pressure Rating (psi):	75	50
Vessel Sizes Available (sq ft):	13.5 - 41 SF	20 - 41 SF
Standard Warranty:	15 Year Limited, Non-Prorated for the first three years	
Manufactured using a multi-layered engineered composite (fiberglass) laminate:	Yes	
Constructed using a dual-containment method. Entire vessel (including domes) is wound with continuous glass roving / epoxy matrix on a computer-controlled, multi-axis winder:	Yes	No
Exterior surface is coated with PARACOTE All-Weather Coating with UV Inhibitors:	Yes	
NSF Listed:	Yes	

S Series Dual Construction Method: Shell & Winding



SL Series Vessel Numbering

Optional, Indicates base tank for stacked pair (B & C Only)

Optional, Indicates reverse manway

LC96-R-ST

Tank Length

Tank Style (A, B, or C)

S = S Series - 75 psi wound;

L = L Series - 50 psi unwound

* All SL Series filters are 42" Dia.

* 48" Long Filters (S-48) are not available in L Series

L Series vessel shown during cycle-testing



Capacity Information (Independent of Style / Configuration)										Dimensions - Side-by-Side			
# Tanks	General System Number	Tank Size	Filtration Area (Sq. Ft.)	Flow (GPM)		Backwash Valve Size/Type	Total Media (cu ft)	Operating Weight (lbs.)	Shipping Weight (lbs.)	Descriptive System Number	Single-Tank and Side-by-Side Systems		
				12 gpm/sf	15 gpm/sf						'W'	'L'	'Hs'
1	S1-48	42" x 48"	13.5	162	203	4" Gray	16.5	5,280	870	*SC1-48-04	44"	82"	47"
	S1-72	42" x 72"	20.0	240	300	6" Clear	26.0	7,920	1,110	*SA1-72-06	44"	107"	67"
	S1-96	42" x 96"	27.0	324	405	6" Clear	36.0	10,560	1,350	*SA1-96-06	44"	122"	67"
	S1-120	42" x 120"	35.0	420	525	6" Clear	45.5	13,200	1,590	SA1-120-06	44"	146"	67"
	S1-144	42" x 144"	41.0	492	615	6" Clear	55.5	15,840	1,830	SA1-144-06	44"	170"	67"
2	S2-48	42" x 48"	27.0	324	405	4" Gray	33.0	10,560	1,740	*SC2-48-06	96"	80"	56"
	S2-72	42" x 72"	40.0	480	600	6" Clear	52.0	15,840	2,220	*SA2-72-06	99"	92"	86"
	S2-96	42" x 96"	54.0	648	810	6" Clear	72.0	21,120	2,700	*SA2-96-06	99"	116"	86"
	S2-120	42" x 120"	70.0	840	1050	6" Clear	91.0	26,400	3,180	SA2-120-08	110"	144"	91"
	S2-144	42" x 144"	82.0	984	1230	6" Clear	111.0	31,680	3,660	SA2-144-08	110"	168"	91"
3	S3-48	42" x 48"	40.5	486	608	4" Gray	49.5	15,840	2,610	*SC3-48-06	152"	80"	56"
	S3-72	42" x 72"	60.0	720	900	6" Clear	78.0	23,760	3,330	*SA3-72-08	152"	94"	91"
	S3-96	42" x 96"	81.0	984	1215	6" Clear	108.0	31,680	4,050	*SA3-96-08	152"	117"	91"
	S3-120	42" x 120"	105.0	1260	1575	6" Clear	136.5	39,600	4,770	SA3-120-10	152"	138"	96"
	S3-144	42" x 144"	123.0	1476	1845	6" Clear	166.5	47,520	5,490	SA3-144-10	152"	162"	96"
4	S4-48	42" x 48"	54.0	648	810	4" Gray	66.0	21,120	3,480	*SC4-48-06	200"	80"	56"
	S4-72	42" x 72"	80.0	960	1200	6" Clear	104.0	31,680	4,440	*SA4-72-08	200"	94"	91"
	S4-96	42" x 96"	108.0	1296	1620	6" Clear	144.0	42,240	5,400	*SA4-96-10	200"	118"	96"
	S4-120	42" x 120"	140.0	1680	2100	6" Clear	182.0	52,800	6,360	SA4-120-10	200"	142"	96"
	S4-144	42" x 144"	164.0	1968	2460	6" Clear	222.0	63,360	7,320	SA4-144-12	200"	168"	100"

Systems highlighted green are available in S Series only. For all others, L Series vessels may be used - replace the 'S' with an 'L'

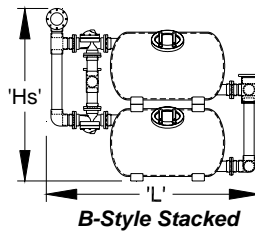
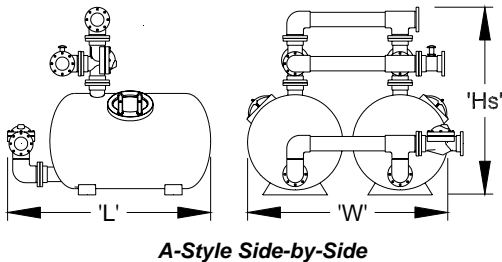

*For systems with an asterisk, SS Series systems may be used with a smaller footprint.

SL Series System Numbering

Optional, Indicates Stacked System (B & C)
 Influent / Effluent Connection Size
 Backwash Control: A = Auto, M = Manual, I = Interface

LC4-72A-08ST

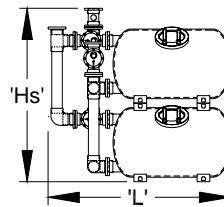

Tank Length
 # Tanks
 Tank Style (A, B, or C)

S = S Series - 75 psi wound;
 L = L Series - 50 psi unwound
 * All SL Series filters are 42" Dia.
 * 48" Long Filters (S-48) are not available in L Series

Dimensions - Stacked Systems							
Style	# Tanks	Descriptive System Number	Filtration Area (Sq. Ft.)	'W'	'L'	'Hs'	
Stacked Systems - B-Style	2	SB2-48-06ST	27.0	44"	98"	107"	
		SB2-72-06ST	40.0	44"	135"	109"	
		SB2-96-06ST	54.0	44"	159"	109"	
		SB2-120-08ST	70.0	44"	191"	109"	
		SB2-144-08ST	82.0	44"	215"	109"	
Stacked Systems - B-Style	4	SB4-48-06ST	54.0	92"	99"	108"	
		SB4-72-08ST	80.0	92"	140"	111"	
		SB4-96-10ST	108.0	100"	166"	119"	
		SB4-120-10ST	140.0	100"	190"	119"	
		SB4-144-12ST	164.0	104"	217"	122"	
Stacked Systems - C-Style	2	SC2-48-06ST	27.0	50"	80"	107"	
		SC2-72-06ST	40.0	50"	114"	109"	
		SC2-96-06ST	54.0	50"	138"	109"	
		SC2-120-08ST	70.0	53"	165"	109"	
		SC2-144-08ST	82.0	53"	189"	109"	
	Stacked Systems - C-Style	4	SC4-48-06ST	54.0	92"	88"	108"
			SC4-72-08ST	80.0	92"	122"	111"
			SC4-96-10ST	108.0	100"	146"	119"
			SC4-120-10ST	140.0	100"	169"	119"
			SC4-144-12ST	164.0	104"	193"	122"

Notes:

- Standard header sizing shown is based on 10 fps max. at 15 gpm per sq. ft.
- For more dimensional detail, consult the appropriate Cut Sheet in our Design Manual.
- For special requirements including non-standard header sizes / locations and systems consisting of more vessels than shown, please contact our Applications Engineering.
- S-48 Vessels are not available in L Series, or A Style. Dimensions above represent C Style.



PARAGON
AQUATICS
 Pentair Water

(845) 452-5500
 Fax: (845) 452-5426
 www.paragonaquatics.com